



# Willard Packaging Co.

*Packaging Supplies  
Manufacturer of Corrugated Boxes &  
Foam Packaging*



Willard Packaging...  
where packaging is everything

**18940 Woodfield Road  
Gaithersburg, MD 20879**



**301.948.7700**

**willardpackaging.com**

**email:sales@willardpackaging.com**

# In Stock Packaging Supplies

**We carry thousands of stock items and hundreds of standard stock boxes in our warehouses. Place your order with us today and have our stock items delivered locally for FREE\* on the next business day.**

Bags, Liners - Bubble, Padded, Poly, Plastic

Biothermal Packaging

Boxes - Corrugated

Bubble Wrap, Bubble Mailers, Bubble Out Bags

Cushioning, Peanuts and Foam Rolls

Transit Cases - Injection Molded, Rotomolded

Edge Protectors

Envelopes / Mailers / Labels

Foam - Urethane, Polyethylene, Polystyrene

Inflatable Packaging - Air Pillows

Paper - Kraft, Newsprint, Tissue

Material Handling & Storage

Moving Blankets, Boxes & Supplies

Packing List Envelopes

Paper Pads

Single Faced Corrugated Rolls

Shrink Wrap & Bundling Film

Steel Banding & Clips

Staples & Staplers

Strapping

Stretch Wrap

Tape

Tubes

Warehouse Equipment

**Serving the  
Mid-Atlantic region  
Since 1962**



\* \$100 minimum for FREE local delivery.

# STOCK BOXES

ItemCode	Description	Test/Flute	ItemCode	Description	Test/Flute
C444	4 x 4 x 4	ECT32	<b>Bin Boxes</b>		
C654	6 x 5 x 4	ECT32	B212	2 x 12 BIN BOXES	200C
C664	6 x 6 x 4	ECT32	B312	3 x 12 BIN BOXES	200C
C666	6 x 6 x 6	ECT32	B412	4 x 12 BIN BOXES	200C
C755	7 x 5 x 5	ECT32	B612	6 x 12 BIN BOXES	200C
C866	8 x 6 x 6	ECT32	B812	8 x 12 BIN BOXES	200C
C888	8 x 8 x 8	ECT32	B1012	10 x 12 BIN BOXES	200C
C955	9 x 5 x 5	ECT32	B1212	12 x 12 BIN BOXES	200C
C975	9 x 7 x 5	ECT32	<b>Binder Boxes</b>		
C1086	10 x 8 x 6	ECT32	BB2	2" BINDER BOX	200C
C10107	10 x 10 x 7	ECT32	BB3	3" BINDER BOX	200C
C101010	10 x 10 x 10	ECT32	<b>Trays</b>		
C11812	11¼ x 8¾ x 12	ECT32	BEER	BEER TRAY	200C
C1182	11¼ x 8¾ x 2	ECT32	<b>Moving Boxes</b>		
C1184	11¼ x 8¾ x 4	ECT32	C161212	SMALL MOVER -1.5 CUBE- 16¾ x 12¾ x 12¾	200C
C1186	11¼ x 8¾ x 6	ECT32	C181618	MEDIUM MOVER -3 CUBE- 18 x 16 x 18	200C
C1188	11¼ x 8¾ x 8	ECT32	C241818	LARGE MOVER -4.5 CUBE- 24 x 18 x 18	200C
C1296	12 x 9 x 6	ECT32	C241824	X-LARGE MOVER -6 CUBE- 24 x 18 x 24	200C
C12108	12 x 10 x 8	ECT32	M33C	3/3 COMBO MATTRESS	200C
C12124	12 x 12 x 4	ECT32	M46C	4/6 COMBO MATTRESS	200C
C12128	12 x 12 x 8	ECT32	MC	CRIB MATTRESS	200C
C121210	12 x 12 x 10	ECT32	MQ	QUEEN MATTRESS	200C
C121212	12 x 12 x 12	ECT32	MSMI	SMALL MIRROR CARTON - INNER	200C
C131313	13 x 13 x 13	200C	MSMO	SMALL MIRROR CARTON - OUTER	200C
C141410	14 x 14 x 10	200C	MRMI	REGULAR MIRROR CARTON - INNER	200C
C141447	14 x 14 x 47	200C	MRMO	REGULAR MIRROR CARTON - OUTER	200C
C15104	15 x 10 x 4	200C	MLMI	LARGE MIRROR CARTON - INNER	200C
C15106	15 x 10 x 6	200C	MLMO	LARGE MIRROR CARTON - OUTER	200C
C151210	15 x 12 x 10	200C	M24WO	24" WARDROBE	200C
C151515	15 x 15 x 15	200C	M24WS	24" ***SHORTY*** WARDROBE	200C
C161610	16 x 16 x 10	200C	C361812	FLAT WARDROBE - 36 x 18 x 12	200C
C161212	16¾ x 12¾ x 12¾ - SMALL	200C	MCB	CHINA BARREL	275BC
C171112	17¼ x 11¼ x 12	200C	<b>Corrugated Pads</b>		
C17116	17¼ x 11¼ x 6	200C	P811	PAD200 8½ x 11	200C
C171162	17¼ x 11¼ x 6	275C	<b>Corrugated Sheets</b>		
C171185	17¼ x 11¼ x 8¾	200C	CS4848	48 x 48 200# CORRUGATED SHEET	200C
C1711852	17¼ x 11¼ x 8¾	275C	CS4870	48 x 70 200# CORRUGATED SHEET	200C
C181212	18¼ x 12¼ x 12	200C	CS4870OW	48 x 70 200# O/W CORR. SHEET	200C
C18126	18¼ x 12¼ x 6	200C	CS4896	48 x 96 200# CORRUGATED SHEET	200C
C181262	18¼ x 12¼ x 6	275C	CS4896OW	48 x 96 200# O/W CORR. SHEET	200C
C18128	18¼ x 12¼ x 8	200C	CS571403	57 x 140 350# D/W CORR. SHEET	350DW
C181618	18 x 16 x 18 - MEDIUM	200C	CS81993OW	81 x 99 350# D/W O/W CORR. SHEET	350DW
C181824	18 x 18 x 24	200C	CS8760	87 x 60 200# CORRUGATED SHEET	200C
C191113	19 x 11 x 13	200C	CS8770	87 x 70 200# CORRUGATED SHEET	200C
C201013	20 x 10 x 13	200C	CS87702	87 x 70 275# CORRUGATED SHEET	275C
C201510	20 x 15 x 10	200C	CS87703	87 x 70 350# D/W CORR. SHEET	350DW
C202020	20 x 20 x 20	350DW	CS8775OW	87 x 75 200# O/W CORR. SHEET	200C
C222218	22 x 22 x 18	200C	CS8799	87 x 99 200# CORRUGATED SHEET	200C
C241212	24 x 12 x 12	200C	CS87992	87 x 99 275# CORRUGATED SHEET	275C
C241812	24 x 18 x 12	200C	CS87993	87 x 99 350# D/W CORR. SHEET	350DW
C241818	24 x 18 x 18 - LARGE	200C	<b>Office</b>		
C241824	24 x 18 x 24 - EXTRA LARGE	200C	M2P	2PC RECORD STORAGE CARTON	200C
C242424	24 x 24 x 24	350DW	MOM	OFFICE MOVE CARTON	200C
C302030	30 x 20 x 30	ECT32C	<b>Export Containers</b>		
C361812	36 x 18 x 12 - FLAT WARDROBE	200C	SV11	SMALL V-11 30¾ x 17¾ x 13	200C
PPB	47 x 41 x 25 - POWER PAK - BOTTOM	200C	LV11	LARGE V-11 35¾ x 23¾ x 23	200C
PPT	47½ x 41½ x 37 - POWER PAK-TOP	200C	DS8A	DS8A 4PC. 350#DW W/SKID 58 x 42 x 45	350DW
C482428	48 x 24 x 28 - COMMERCIAL BIN	350DW	DS11A	DS11A RSC 350# 40½ x 28 x 24¼	350DW



**Corrugated  
Recycles**



# Willard Packaging Co.

## Types of Boxes

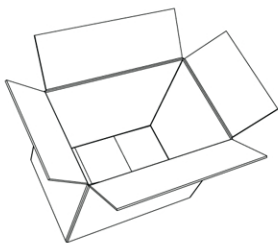

Regular Slotted Container (RSC)



Die Cut Box (D/C)

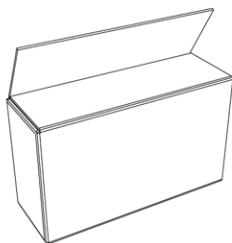

Full OverLap (FOL)

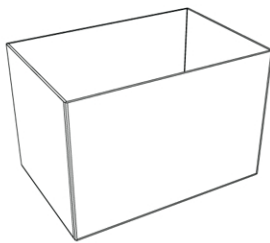

Half Slotted Container (HSC)

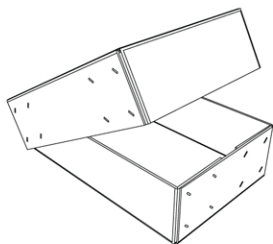

Telescoping Box

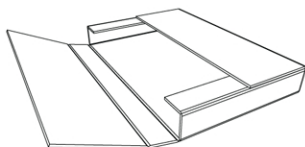

One Piece Folder (OPF)

## How to Measure a Box

NOTE: ALL DIMENSIONS ARE INSIDE DIMENSIONS

- ① Length is always the longest side of the box that has a flap
- ② Width also has a flap, but is always the side shorter than the length
- ③ Depth (or Height) is the only dimension without a flap

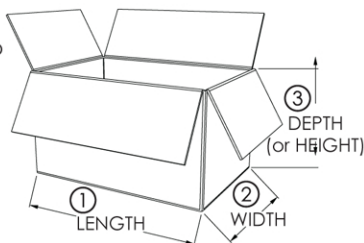

301.948.7700

Fax 301.963.2375

[willardpackaging.com](http://willardpackaging.com)

# MAILING AND SHIPPING BAGS

## White & Kraft Rigid Mailers – Self Seal

- #1 6 x 8
- #2 7 x 9
- #3 9 x 11 ½
- #4 9 ¾ x 12 ¼
- #5 11 x 13 ½
- #6 12 ¾ x 15

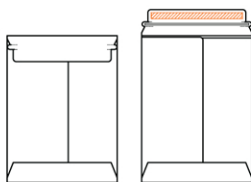

## Kraft Bubble Mailers – Self Seal

- #000 4 x 8
- #00 5 x 10
- #0 6 x 10
- #1 7 ¼ x 12
- #2 8 ½ x 12
- #3 8 ½ x 14 ½
- #4 9 ½ x 14 ½
- #5 10 ½ x 16
- #6 12 ½ x 19
- #7 14 ¼ x 20

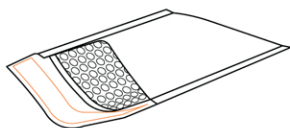

## Padded Recyclable Mailers – Self Seal

- #0 6 x 9
- #2 11 x 9
- #4 13 x 9
- #5 11 x 15
- #6 13 x 18

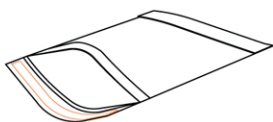

## Poly Mailers White – Self Seal

- #1 6 ¼ x 9
- #2 7 ½ x 10 ½
- #3 9 x 12
- #4 10 x 13
- #5 12 x 15 ½
- #6 14 ½ x 19
- #7 19 x 24



## Bubble Poly Mailers – Self Seal

- #0 6 ½ x 9 ¼
- #1 7 ¼ x 11 ¼
- #2 8 ½ x 11 ¼
- #3 8 ½ x 13 ¾
- #4 9 ½ x 13 ¾
- #5 10 ½ x 15 ¼
- #6 12 ½ x 18 ¼
- #7 14 ½ x 19 ¼

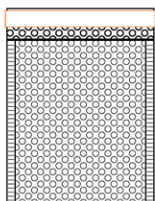



# Willard Packaging Co.

## Packing List Envelopes

PQ-10	4 1/2 x 5 1/2	Orange Invoice Enclosed
PQ-11	4 1/2 x 5 1/2	Plain Packing List
PQ-12	4 1/2 x 5 1/2	Packing List Enclosed
PQ-13	4 1/2 x 5 1/2	Invoice Enclosed
PQ-18	7 x 5 1/2	Packing List Enclosed
PQ-21	7 x 5 1/2	Plain Packing Enclosed
PQ-24	5 1/2 x 10	Plain Packing List
PQ-28	5 1/2 x 10	Plain Packing List Enclosed
PQ-70	10 3/4 x 6 3/4	Plain (Perforated Face)

## POLY

### Poly Bags

2 x 3	8 x 10
3 x 3	9 x 12
3 x 5	10 x 14
4 x 6	10 x 16
5 x 7	12 x 15
6 x 6	12 x 18
6 x 9	12 x 20
6 x 12	15 x 20
8 x 8	20 x 30

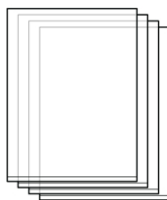
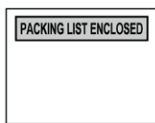

### Seal Top Bags

2 x 3	6 x 8
3 x 4	6 x 9
3 x 5	9 x 12
4 x 6	12 x 15
4 x 8	13 x 18



### Poly Rolls

4' x 100'	8' x 100'
-----------	-----------

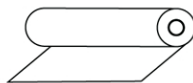

### Furniture Covers

Chair	70" x 54"
Love Seat	100" x 50"
Sofa	152" x 50"



### Trash Can Liners

10 Gallon	33 Gallon
55 Gallon	



301.948.7700

Fax 301.963.2375

[willardpackaging.com](http://willardpackaging.com)

# CUSHIONING, PEANUTS & FOAM

## Kraft Paper Rolls

12" – 50#	18" – 50#
24" – 50#	30" – 40#
30" – 50#	30" – 70#
36" – 30#	36" – 40#
36" – 50#	36" – 90#
48" – 50#	48" – 90#

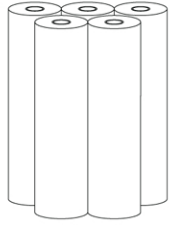

## Bogus Paper

18" – 50#	30" – 70#
-----------	-----------

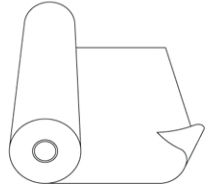

## 3-Ply Paper Pads

## Single Faced Corrugated

250' Rolls in Widths:

12"	18"	24"
36"	48"	60"

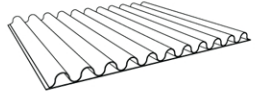

## Newsprint Sheets

- 10lb. Box of Newsprint
- 25lb. Bundle of Newsprint
- 24" Roll of Newsprint

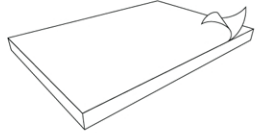

## Tissue Paper Sheets

- Plain White
- Anti-Tarnish

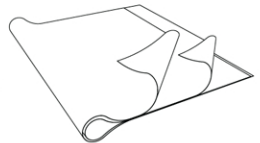

## Air Bubble Cushioning

Small Cell – Plain & Anti-Static Available

12" x 500'	24" x 500'	48" x 500'
------------	------------	------------

Medium Cell – Plain & Anti-Static Available

12" x 375'	24" x 375'	48" x 375'
------------	------------	------------

Large Cell – Plain & Anti-Static Available

12" x 250'	24" x 250'	48" x 250'
------------	------------	------------

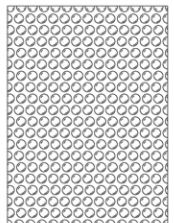

## Bubble Pak Dispenser Box

- 12" x 175' Small Cell
- 12" x 100' Large Cell

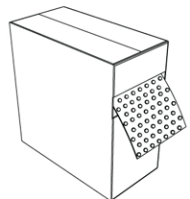

\* \$100 minimum for FREE local delivery.



# Willard Packaging Co.

## Polyethylene Foam Planks

Available in White, Blue, Black, and Pink Anti-Static

1.2# 1.7# 1.8# 2.0# 2.2# 4.0# 6.0# 9.0# – Density

Not all colors available in all Densities

Other Densities Available

## Polystyrene Planks

24" x 48" x 1/2"

24" x 48" x 1"

24" x 48" x 1 1/2"

24" x 48" x 2"

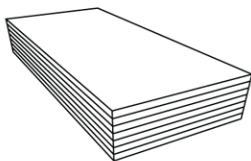

## Polyurethane Planks

24" x 72" x 1" (10 per bundle)

24" x 72" x 2" (5 per bundle)

## Polypropylene Foam Rolls

1/4" x 72"

## Polyethylene Foam Rolls

3/32" x 72"

1/8" x 48"

1/8" x 72"

1/4" x 72"

1/16" x 72" - Perf at 12"

1/8" x 72" - Perf at 12"

Other Sizes & Perfining Available

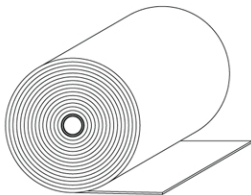

## Loose-Fills (Peanuts)

Wil/Flo Peanuts

Anti-Static Peanuts

Eco-Foam Starch Peanuts (Eco-Friendly!)

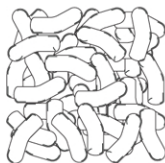

## Air Bag Cushion Machinery

High-Speed – on demand air bag machines

A variety of machines, bag sizes

and styles to meet any application

Paper Machines

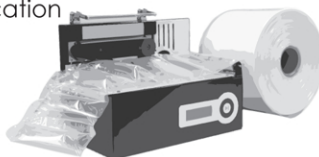

301.948.7700

Fax 301.963.2375

[willardpackaging.com](http://willardpackaging.com)



# STRAPPING & BUNDLING

## Steel Banding & Seals

1/2"      5/8"      3/4"      1-1/4"

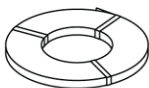

## Poly Strapping

1/2" x 7200'

Poly Strapping Kit

Tools and Dispensers for Steel and Poly Strapping

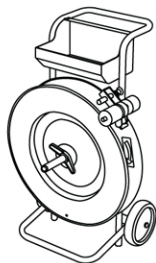
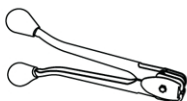

## Twine

1-Ply Poly Twine

## Stretch Wrap

Clear

3" x 1000'      15" x 1500'

5" x 1000'      18" x 1500'

12" x 1500'      20" x 1000'

20" x 5000' Machine

5" x 1000' Extended Core

Black - 18" x 1500'

All Stretch Wrap Tools

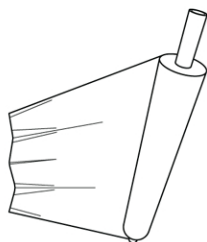

## Shrink Films

12" x 75 Gauge

18" x 75 Gauge

14" x 75 Gauge

20" x 75 Gauge

16" x 75 Gauge

## Pressure Sensitive Labels

GLASS HANDLE WITH CARE

FRAGILE ↑ THIS SIDE UP

HANDLE WITH CARE FRAGILE THANK YOU

DELICATE INSTRUMENTS

REFRIGERATE UPON ARRIVAL

FRAGILE



# INSULATED SHIPPERS & SUPPLIES

Insulated Shipping Containers

Refrigerant Gel Packs

Cool Shield Bubble Rolls

Biothermal Packaging

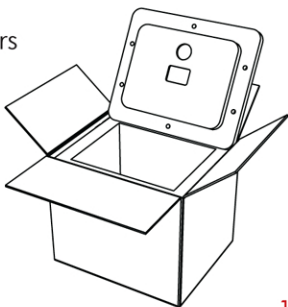



# Willard Packaging Co.

## TAPE & DISPENSERS

### Box Sealing

Reinforced Tapes

3" Kraft – 375'

3" White – 375'

Printed "Fragile"

Printed "Warning"

Kraft Tapes

Carton Sealing Tape 2" x 55yds.

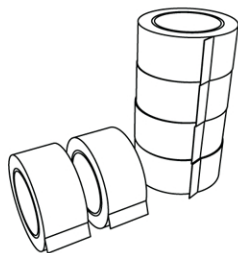

### Pressure Sensitive Tape

2" x 55yds. – Tan & Clear – Economy

2" x 110yds. – Clear – Economy

2" x 110yds. – Clear – Industrial

2" x 110yds. – Clear – Heavy Duty

3" x 110yds. – Clear – Industrial

3" x 110yds. – Clear – Heavy Duty

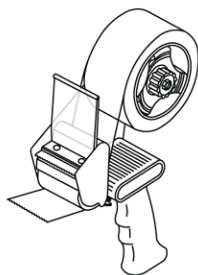

### Misc. Tapes

2" & 3" – Machine Tape

Masking

Filament

Duct

Label Protection

Printed Tapes

2" & 3" Blue Painters Tape

Machine & Hand Held Dispensers

Available for all above tapes

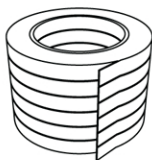

## MISCELLANEOUS SUPPLIES

Mailing Tubes & Caps

2" x 24"

2" x 36"

3" x 36"

Moving Blankets

Staplers & Supplies

Spray Adhesive

Mil-Spec Barrier Film / Heat Sealers

Hand Trucks & Dollies

Sweeping Compound

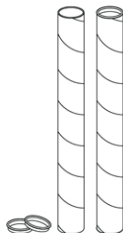
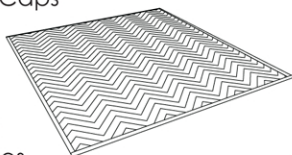

**301.948.7700**

**Fax 301.963.2375**

**willardpackaging.com**

# Foam Division

Willard Packaging specializes in providing effective foam solutions for a wide range of product applications – from shipment packaging to medical products. Additionally, we offer an environmentally friendly foam solution that is 100% recyclable!



**100% RECYCLABLE**

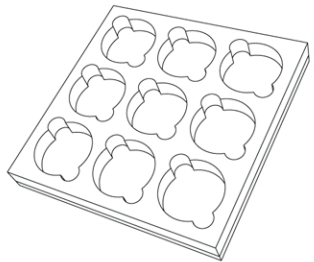
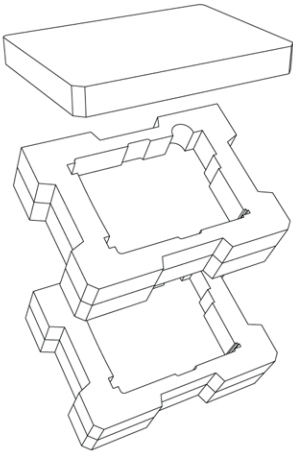
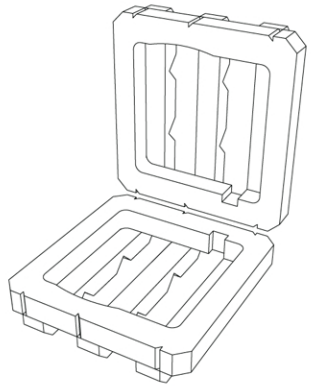
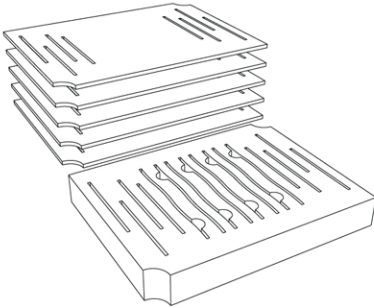

## In-House Design Services

Our experienced design department can handle any packaging requirement and is helpful in making suggestions or answering questions regarding the use of transit cases, foam or corrugated products. With the utilization of the latest CAD/CAM equipment, we are able to produce accurate product samples and drawings. We are also able to provide 3-D virtual prototypes.

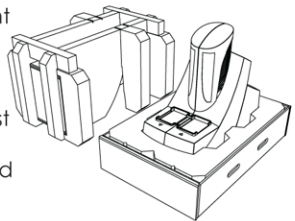

\* \$100 minimum for FREE local delivery.



# Willard Packaging Co.

## Case Division

Willard's in-house Design Team will offer you an innovative custom case solution for your application from the inside out, giving careful attention to many factors: the weight and fragility of your product, the shock and vibration shipments will impose, the most efficient use of the case's interior space and how the case will be used at its destination.

Our case division serves the following industries and product lines:

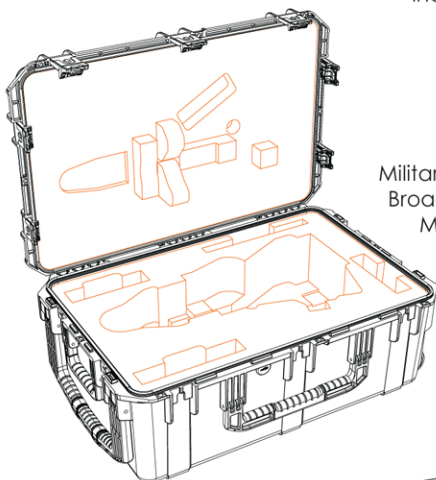

- Aerospace Equipment
- Scientific Instrumentation
- Computer & Electronics
- Audio & Video
- Firearms
- Military & Government Agency
- Broadcast & Communications
- Medical & Pharmaceutical
- Sales Demonstrations
- Consumer Products
- Sales & Marketing
- OEM & Industrial
- Trade Shows

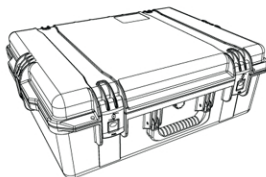
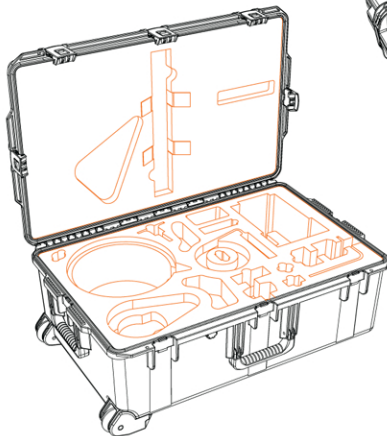

301.948.7700

Fax 301.963.2375

[willardpackaging.com](http://willardpackaging.com)

# Custom Designed Boxes

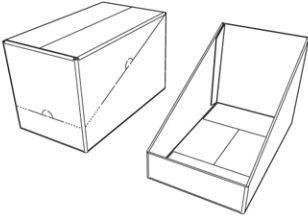

SRP- Shelf Ready Packaging

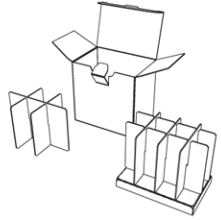

Lock Top & Dividers

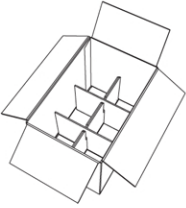

Integrated Dividers



Tab Closures



Bins / Totes

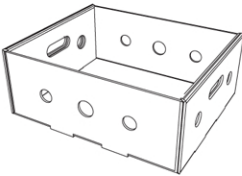

Aerated Boxes

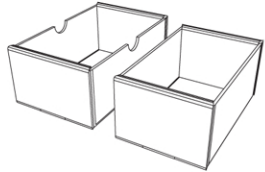

Telescoping

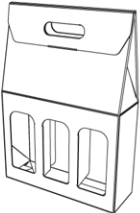

Bottle Carriers

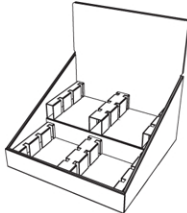

Counter Displays



Presentation Packaging

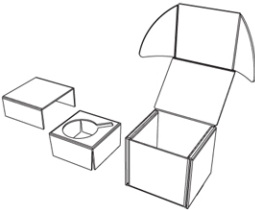

Product Mailers

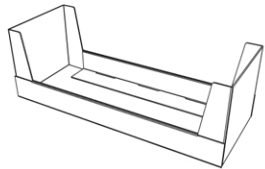

No Glue Packaging

Transport and protect products with custom corrugated packaging designed & manufactured by Willard Packaging. Our in-house Design Department along with our in-house manufacturing provides better shipping and handling for your unique products.